

Volets Roulants Tradi

- Manuel: Sangle - Treuil - Ressort automatique
- Electrique: Avec interrupteur - Avec télécommande
- Les lames suivantes sont disponibles:
 - PVC: WP37, WP60
 - Aluminium: WA39, WA40, WA41, WA40H, WA55, WA55H

Coulisses

Lames de 9 mm

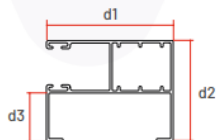

FHTF20
d1: 53 mm,
d2: 42 mm et d3: 20 mm

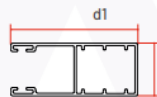

HTF25
d1: 53 mm
et d2: 22 mm

Lames de 14 mm

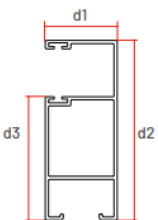

Clips 51
d1: 30 mm,
d2: 75 mm et d3: 51 mm



U30x20x30x1,5
d1: 30 mm
et d2: 20 mm

Sous-lame

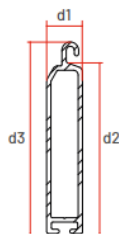

Lame 9 mm
d1: 7,5 mm,
d2: 35,61 mm et d3: 40 mm

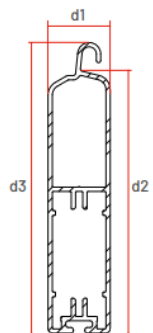

Lame 14 mm
d1: 13 mm, d2: 53,80 mm
et d3: 60,70 mm

Volets Mini Caisson WA39

- Manuel: Sangle - Treuil - Ressort automatique
- Electrique: Avec interrupteur - Avec télécommande
- Les lames suivantes sont disponibles:
 - PVC: WP37
 - Aluminium: WA39, WA40, WA41, WA40H

- Caisson 137: d1: 137 mm et d2: 137 mm
- Caisson 150: d1: 150 mm et d2: 150 mm
- Caisson 165: d1: 165 mm et d2: 165 mm
- Caisson 180: d1: 180 mm et d2: 180 mm
- Caisson 205: d1: 205 mm et d2: 205 mm
- Caisson 230: d1: 230 mm et d2: 230 mm

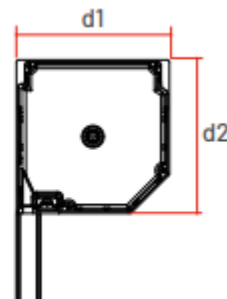

Coulisses

9 mm

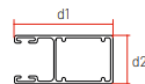

HF
d1: 45 mm et d2: 22 mm

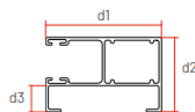

FHTF12
d1: 53 mm, d2: 34 mm et
d3: 12 mm

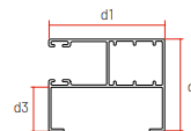

FHTF20
d1: 53 mm, d2: 42 mm et
d3: 20 mm

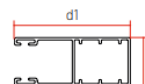

HTF25
d1: 53 mm et d2: 22 mm



HTF40
d1: 67 mm et d3: 22 mm



M-HTF
d1: 79 mm et d3: 22 mm

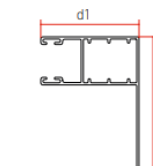

LHF
-d1: 45 mm et d2: 60 mm

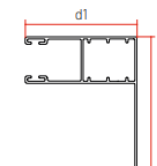

LHTF25
d1: 53 mm et d2: 60 mm

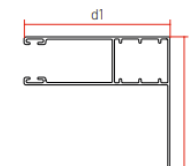

LHTF40
d1: 67 mm et d2: 60 mm

Sous-lame

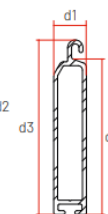

Lame 9 mm
d1: 7,50 mm, d2: 35,61 mm
et d3: 40 mm

Volets Mini-Caisson WA55

- Manuel: Ressort automatique
- Electrique: Avec interrupteur - Avec télécommande
- Aluminium: WA55, WA55H
- Caisson 250: d1: 250 mm et d2: 250 mm
- Caisson 300: d1: 300 mm et d2: 300 mm

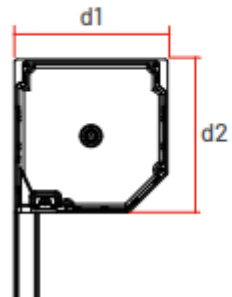

Coulisses

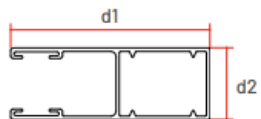

Lames de 14 mm

d1: 75 mm et d2: 28 mm

Sous-lame

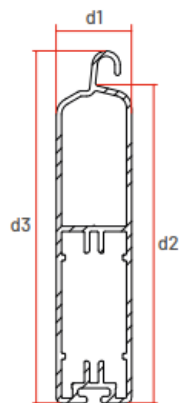

Lames de 14 mm

d1: 13 mm, d2: 53,80 mm et
d3: 60,70 mm

Grilles Roulantes WA84

Une porte roulante est uniquement disponible avec la manoeuvre électrique, donc commandé par un interrupteur ou une télécommande. Une protection sous-lame et une sécurité anti-déroulement sont toujours comprises. On utilise toujours un axe avec un diamètre de 102 mm.

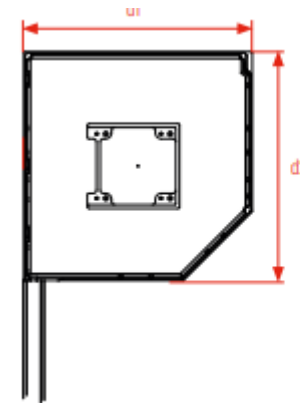

Caisson 300

d1: 300 mm
d2: 300 mm

Lame

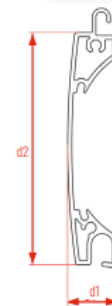

WA79 lame

d1: 19 mm
d2: 79 mm

Ouverture des lames: 100x52
Largeur max: 4000 mm
Hauteur max: 3200 mm
Surface max: 12,80 m²

Sous-lame



d1: 18,3 mm
d2: 86 mm

Coulisses

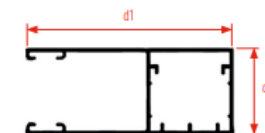

d1: 98 mm
d2: 36 mm

Portes Roulantes WA77L

Une porte roulante est uniquement disponible avec la manoeuvre électrique, donc commandé par un interrupteur ou une télécommande. Une protection sous-lame et une sécurité anti-déroulement sont toujours comprises. Tenu compte avec la largeur du volet, on utilise toujours un axe avec un diamètre de 70 mm ou 102 mm.

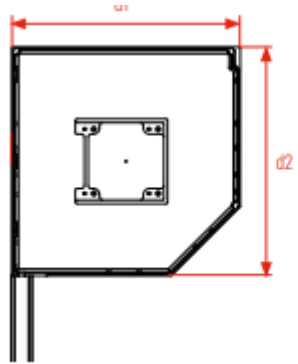

Caisson 300
d1: 300 mm
d2: 300 mm

Lame



WA77L lame
d1: 19 mm
d2: 77 mm

Largeur max: 4000 mm
Hauteur max: 3200 mm
Surface max: 12,80 m²

Sous-lame



d1: 18,3 mm
d2: 86 mm

Coulisses

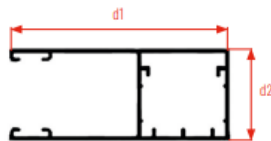

d1: 98 mm
d2: 36 mm

Gamme complète de Lames de volet

Lames en PVC

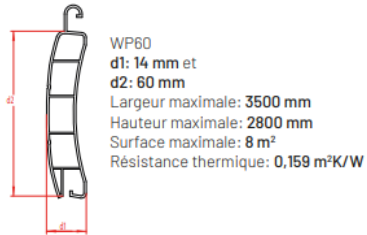
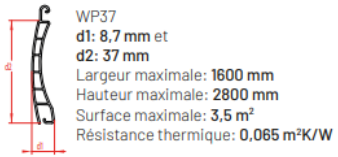

Lames en aluminium

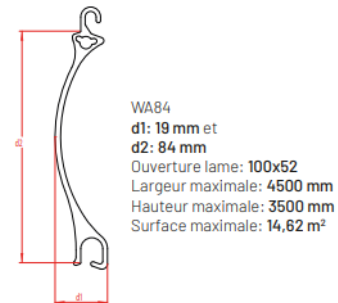
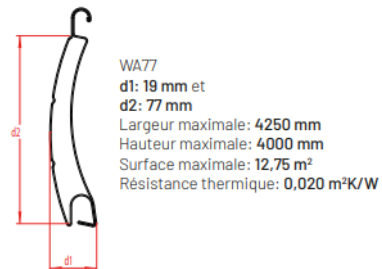
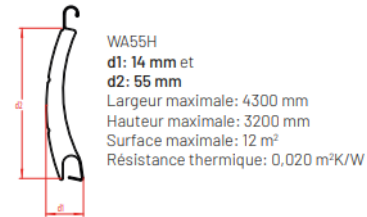
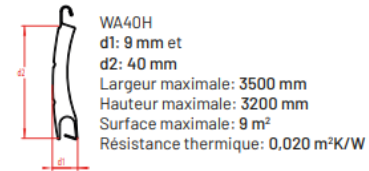
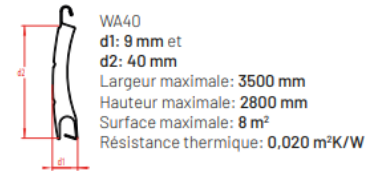
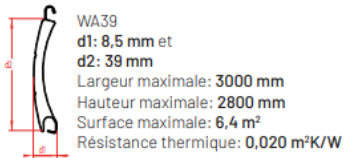

Wilms Shutter Collection

	Code 19 White ± RAL 9016	WA39 Stand. WASS Stand. WA40 Stand. WASSH Stand. WA40H Stand.		Code 21 White ± RAL 9010	WA39 Stand. WASS Stand. WA40 / WASSH / WA40H /
	Code 61 Cream White ± RAL 9001	WA39 Stand. WASS Stand. WA40 Stand. WASSH / WA40H /		Code 23 Cream ± RAL 1015	WA39 Stand. WASS Stand. WA40 Stand. WASSH / WA40H /
	Code 22 Brown ± RAL 8019	WA39 Stand. WASS Stand. WA40 Stand. WASSH / WA40H /		Code 18 Grey ± RAL 7038	WA39 Stand. WASS Stand. WA40 Stand. WASSH / WA40H /
	Code 33 Quartz Grey ± RAL 7039	WA39 Suppl. WASS / WA40 / WASSH / WA40H /		Code 09 Antracit Grey ± RAL 7016	WA39 Stand. WASS Stand. WA40 Stand. WASSH / WA40H /
	Code 20 Natural Alu ± RAL 9006	WA39 Stand. WASS Stand. WA40 Stand. WASSH / WA40H /		Code 83 Grafite	WA39 Suppl. WASS / WA40 / WASSH / WA40H /
	Code 44 Black ± RAL 9011	WA39 Suppl. WASS Suppl. WA40 / WASSH / WA40H /			

Volets Monobloc

- Manuel: Sangle - Treuil - Ressort automatique
- Electrique: Avec interrupteur - Avec télécommande
- Les lames suivantes sont disponibles:
 - PVC: WP37
 - Aluminium: WA39
- Caisson 175: d1: 209 mm et d2: 175 mm
- Caisson 214,5: d1: 247 mm et d2: 214,5 mm

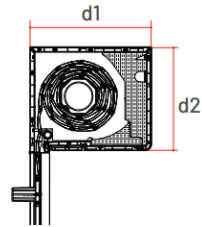

Coulisses

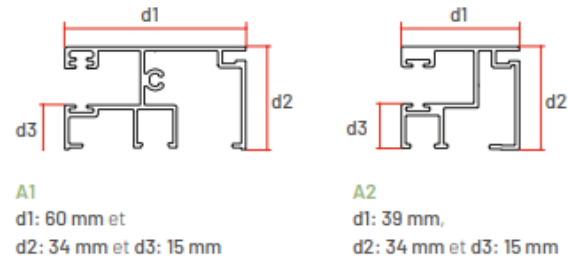
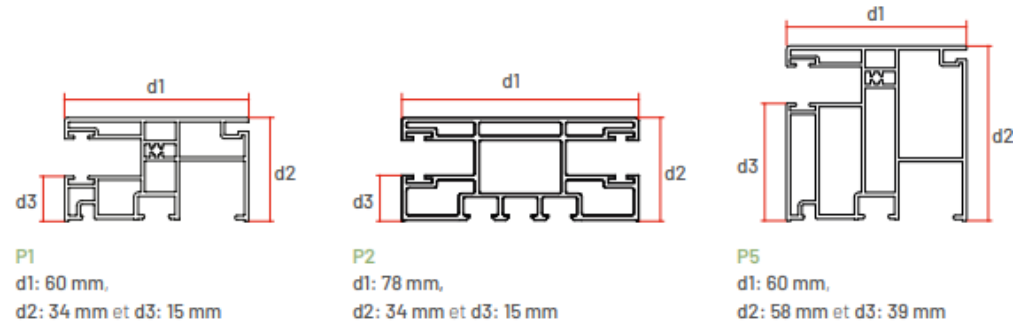

Ecarteurs

Coulisses P2 et A2 sont seulement utilisé comme coulisse centrale. Profil d'élargissement pas possible pour coulisse P2.

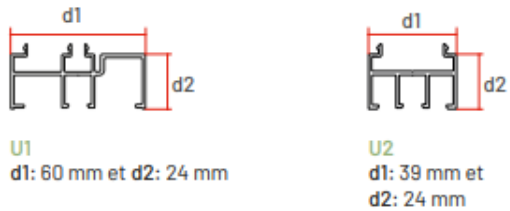

Sous-lame

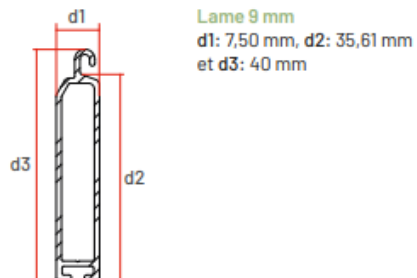

Volet Monobloc Rolvent

- Manuel: Sangle - Treuil - Ressort automatique
- Electrique: Avec interrupteur - Avec télécommande
- Les lames suivantes sont disponibles:
 - PVC: WP37
 - Aluminium: WA39
- Sans isolation acoustique - Caisson 175: d1: 234 mm et d2: 177 mm
- Avec isolation acoustique - Caisson 175: d1: 234 mm et d2: 177 mm
- Sans isolation acoustique - Caisson 214,5: d1: 273 mm et d2: 216 mm
- Avec isolation acoustique - Caisson 214,5: d1: 273 mm et d2: 216 mm

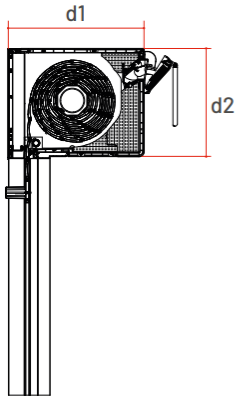

Sans isolation acoustique

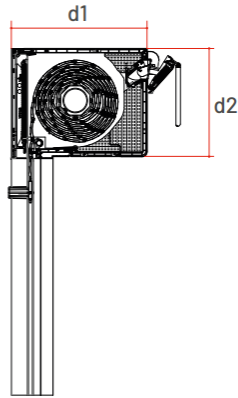

Avec isolation acoustique

Coulisses

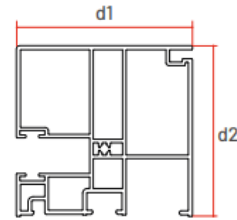

P4
d1: 60 mm et d2: 58 mm

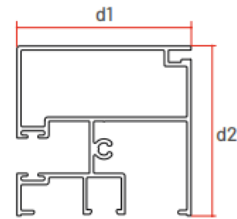

A4
d1: 60 mm et
d2: 58 mm

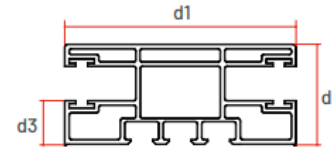

P2
d1: 78 mm et d2: 34 mm

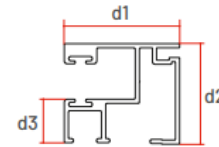

A2
d1: 39 mm,
d2: 34 mm et d3: 15 mm

Sous-lame

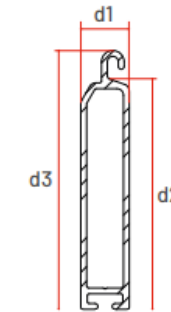

Lame 9 mm
d1: 7,50 mm, d2: 35,61 mm
et d3: 40 mm

Ecarteurs

Coulisses P2 et A2 sont seulement utilisé comme coulisse centrale. Profil d'élargissement pas possible pour coulisse P2.

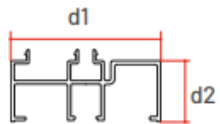

U1
d1: 60 mm et d2: 24 mm

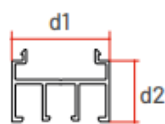

U2
d1: 39 mm et d2: 24 mm

Grille d'aération

Longueur disponible: 800 mm et 1200 mm.

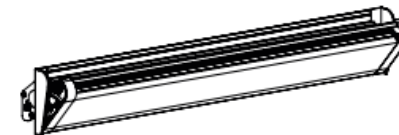

Chiffres clés PEB

- Débit grille Type A - Longueur = 800 mm : 40,8 m³/h (NL à 1Pa : 6,98 l/s)
- Débit grille Type B - Longueur = 1200 mm : 61,2 m³/h (NL à 1Pa : 10,48 l/s)